

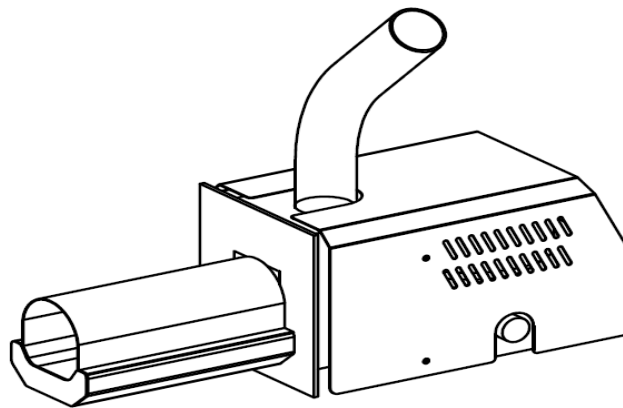

## **Wood pellet burner Nani 35 & Nani 50**



## **Installation & User Manual**

This manual is for the Installer. Read, understand, and follow these instructions for safe installation and operation.

## Contents

1. Warnings, Cautions, and Notes.....	3
2. The principle of working .....	4
3. Technical specifications .....	4
4. Boiler .....	5
5. Chimney .....	5
6. Unpacking and Installing the burner .....	6
7. Description of the controller .....	7
8. Operation functions .....	9
9. Parameter's .....	11
10. Manufacturer's menu .....	14
11. Room thermostat .....	18
12. First use .....	19
13. Start of the burner .....	19
14. Stop of the burner .....	20
15. Cleaning burner's chamber .....	20
16. Restart the burner after an error .....	21
17. Feeder's filling rocedure .....	21
18. Self cleaning .....	22
19. Burner's safety systems .....	22
20. Errors .....	23
21. Electrical diagram .....	24
22. Warranty .....	25

# 1. Warnings, Cautions, and Notes

Read the safety instructions carefully before installation. Always follow the safety instructions during installation and during maintenance



**Electric switch must be used to the power supply cable as an emergency stop**

Always follow the instructions for operations and service.

Installation, operation, service, and other work must be carried out by qualified personnel in accordance with local codes and regulations.

Children and adults should be alerted to the hazards of high surface temperatures and should stay away to avoid contact to skin and / or clothing.

Young children should be carefully supervised when they are in the same room with the burner.

There is a risk of burn from touching the equipment during operation. The burner casing, burner body, flange, and flame trap pipe are hot surfaces during operation. Keep children away and do not touch the equipment during operation.

All electrical installation and service work shall be done by certified and qualified personnel in accordance with local codes and regulations.

Do not perform electrical work unless you have the required qualifications. Perform a complete burner shutdown and disconnect the power supply prior to performing any work on the burner. Observe all guidelines with respect to installation, service, or cleaning.



Only wood pellets are to be used with this burner. No other fuel is to be used in the burner.

**NEVER BURN ANY TYPE OF CORN, CHERRY PITS, STICKS OR OTHER TYPES OF FUEL IN THE BURNER.**

Burning wood pellets according to recommendations and the specifications set forth will assure longer burner life and lessen potential maintenance issues.



**DO NOT** install in a sleeping room.

**DO NOT** connect to any air distribution duct or system.

**DO NOT** terminate the vent in any enclosed or semi enclosed area, such as; carports, garage, attic, crawl space, under a sun deck or porch, narrow walkway or closed area, or any location that can build up a concentration of fumes such as a stairwell, covered breezeway etc.

## 2. The principle of working

The burner's operation is based on providing fuel via controlling the feeder appropriately and also the air fan which steers the burning process. After reaching a particular temperature of the heating water, the burner goes into the mode of maintaining the temperature or switches the burner completely off. The ignition of fuel starts automatically with the help of an igniter and the fire is detected by the fire sensor.

The burner has three modes of operation: Continuous/Single/Analogue (*see paragraph 9 / page 12*)

The burner can also control Hot Usage Water (WUW or HUW) pump or buffers tank's pump. The WUW pump starts working when the regulator detects too low temperature of the WUW buffer. It is also possible to stipulate the working mode of the WUW pump – with a priority or without it. The burner can be also controlled (ON/Off) by the Room Thermostat or by any external thermostat. The burner is also equipped with the self-control systems (detecting the malfunction of the temperature's sensors) and mechanisms monitoring the furnace's work preventing from going beyond the range of safety for the installation of the central heating.

## 3. Technical specifications

Type	Nani 35	Nani 50
Heat output	10-35kW	10-50kW
	8,600-30,100Kcal	8,600-43,000Kcal
Maximum pellet consumption	2-7.45kg/hr	2-10.5kg/hr
Average pellet consumption/day	8-55kg	8-80kg
Length (total)	610mm	630mm
Width	210mm	220mm
Height with feeding pipe	420mm	485mm
Height without feeding pipe	225mm	225mm
Diameter	Φ 137mm	Φ 158mm
Power supply	230Volt / 80Hz	230Volt / 80Hz
Average power consumption	30-40Watt (approx.)	30-40Watt (approx.)
Fuel	Wood pellet φ 6-8mm, humidity <10%	Wood pellet φ 6-8mm, humidity <10%
Weight	14kg	17kg
Feeder's length	1,5m	1,5m

## 4. Boiler

It is important to check that the combustion chamber in the boiler is big enough to ensure that the flame does not come in contact with the water-cooled walls. Verify that the boiler's capacity range complies with the burner. There must be enough space for the ash to accumulate. The exhaust gas channels should not be so narrow that they can easily be clogged with ash.

The distance between the front edge of the burner and the rear part of the combustion chamber should be at least 300mm for low burner's power (10-20kW) If the burner's power increase then the distance must be increased. This distance is also depended on the boilers construction and if the boiler is (oil/gas boiler or wood boiler)

The minimum distance to the bottom of the fireplace also depends on the boiler design. There must be enough space for the quantity of ash build up that is created during at least one week's use in the winter heating season.

## 5. Chimney

We recommend that you have a local chimney sweeper or other corresponding authority make an inspection and provide advice and instructions on the chimney measurements in accordance with local codes and regulations.

The chimney should then of a length and diameter that gives a draught of **10 - 25 Pa**. Measures have to be taken if the chimney is smaller or much larger in diameter in order to give the proper draught and flow.

If there is not enough draught in the chimney, exhaust gases stack in boiler's combustion chamber or in the chimney with the risk of explosion. Also, gas flow into the boiler's room can happened.

Always check the exhaust gas temperature. Directly after the boiler it should be from 160° C to 250° C.

Too high a temperature can damage the chimney and is not economical.

Too low a temperature, a very high chimney, or a large chimney diameter creates a risk for condensation that can cause corrosion and damage due to freezing.

## 6. Unpacking and installing Nani wood pellet burner

### 6.1 Unpacking

It is included in the box:

- ✓ Burner Nani 35 / Nani 50
- ✓ Electronic controller
- ✓ Elbow metal pipe
- ✓ Plastic flexible pipe  $\Phi 60$  for Nani 35 /  $\Phi 76$  for Nani 50
- ✓ Gasket (white insulation flange)
- ✓ Scratcher for removing the ash
- ✓ Clamps for tighing the plastic pipe
- ✓ Screws for mounting the burner on the boiler
- ✓ Manual
- ✓ Self cleaning pipe (optional)
- ✓ Flange-adaptor (optional)
- ✓ HUW sensor (optional)

Note: The feeder is delivered at a separated box itself.

### 6.2 Installing

1. Remove the burner from the box
2. Mount the burner on the boiler's door and srew it
3. If the boiler's fire chamber is small, it is suggested the flange-adaptor to be used between the boiler and the burner
4. Screw the black elbow pipe on the burner's top
5. Mount the burner's controller (black casing) at a convenience location.

Note: In case a room thermostat needs to be connected on the controller, it is better to connected before the controller is mounted anywhere. The connection for the Room thermostat is located inside the controller on **pins 1 & 2**.

6. Connect the water pump (circulator) with the black cable coming out of the vontroller
7. Place the feeder in a silo / tank
8. Connect the controlelr with the feeder using the fast connectors (IEC connectors)
9. Turn the power ON and **follow the instruction on paragraph 11 / page**

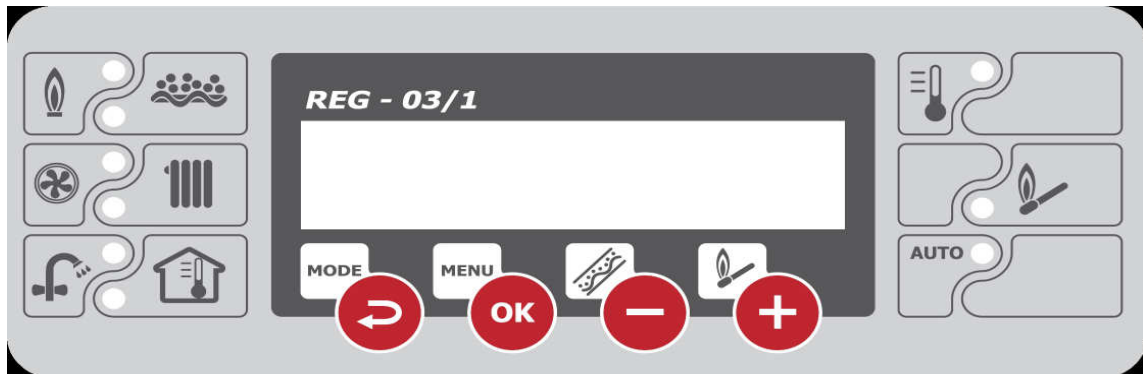

## 7. Description of the controller



Description:

- ◆ Diodes signalling the status of outputs and the working mode of the driver,
- ◆ LCD screen used for communication between the device and the user,
- ◆ Buttons steering the driver's work.

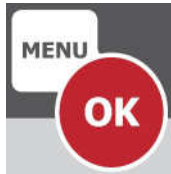
### 7.1 DESCRIPTION OF BUTTONS:

Πλήκτρο	Λειτουργία	
	1	Changes the burner's working mode - <b>"STOP"</b> , <b>"IGNITION"</b> , <b>"AUTOMATIC WORK"</b> .
	2	Return to the previous menu
	1	Entry on the Menu's parameters
	2	Saves the change of a parameter
	1	In the <b>Ignition MODE</b> activates the feeder for the time specified on the parameter "Filling Feeder Time"
	2	<ul style="list-style-type: none"> <li>• Go to the previous menu or parameter</li> <li>• Decreases the value of a parameter</li> </ul>
	1	<ul style="list-style-type: none"> <li>• In the <b>Ignition MODE</b> activates the ignition procedure</li> </ul>
	2	<ul style="list-style-type: none"> <li>• Go to the menu menu or parameter</li> <li>• Increases the value of a parameter του καυστήρα.</li> </ul>

## 7.2 TECHNICAL CHARACTERISTICS OF THE CONTROLLER

<b>Sensors:</b>	KTY-210
<b>Measurement range:</b>	0 – 120 °C
<b>Measurement resolution:</b>	0.1 °C
<b>Time of measurements:</b>	1 s
<b>Data's reading:</b>	LCD screen 2x20 signs
<b>Steering outputs:</b>	<ul style="list-style-type: none"><li>• Igniter: ~230V 2A (0.8A)</li><li>• Feeder: ~230V 2A (0.8A)</li><li>• Burner's fan: ~230V 2A (0.8A)</li><li>• CH pump: ~230V 2A (0.8A)</li><li>• WUW pump: ~230V 2A (0.8A)</li><li>• Cleaning System</li></ul>
<b>Protection:</b>	<ul style="list-style-type: none"><li>• Electric Fuse 4A</li></ul>
<b>Inputs:</b>	<ul style="list-style-type: none"><li>• Room thermostat: Open contact</li><li>• Temperature sensors: KTY-210</li><li>• Temperature STB (95°C)</li></ul>
<b>Visual signalling:</b>	<ul style="list-style-type: none"><li>• LED diodes Signalling the status of outputs</li><li>• LCD screen Messages, measurements, settings</li></ul>
<b>Power supply:</b>	~230 V 50Hz 2VA
<b>Working temperature:</b>	5°C - 50°C



## 8. Operation functions

- After switching the burner on, it is appeared on the LCD screen the program's logo defining the type of the driver and the version of the current software

PELLETS DRIVER  
\*\* REG-03/G v4.0 \*\*

- While activating, the burner carries out a test of the connected sensors. In case of one lacking, on the screen appears an appropriate message (---). The work of the burner without a heating water temperature sensor (CH) is blocked and an emergency mode is activated (CH pump is still on).

CH:---- °C WUW:---- °C  
STOP

- Correct connection of sensors causes displaying of actual CH furnace's temperature and the temperature of useful warm water of the WUW buffer (if the function is active). On the screen appears which function is currently used by the driver.

**CH temperature WUW temperature**  
CH:39.5°C WUW:23.6°C  
IGNITION...  
**Burner function**

The burner may work in three working modes ("STOP", "IGNITION", "AUTOMATIC WORK"). The mode changes when the "MODE/↶" button is pressed. Activating the "STOP" mode is possible in all modes after pressing the "MODE/↶" button for 3 seconds. When Stop is activated, the burner goes at "Burning off" process (if there is fire) and the at "Cleaning" process.

When the burner is activated for first time, it is on "Stop" mode. Every next time, its status is saved in the regulator's non-volatile memory. Activating the driver again, automatically causes switching on of the lately used working mode.

In the table beneath a short description of particular functions of the burner, activated depending on the working mode of the driver, is shown.

<b>FUNCTION'S NAME</b>	<b>DESCRIPTION OF FUNCTIONS</b>
<b>STOP</b>	Burner stopped.
<b>FEEDER FILLING</b>	Filling the feeder. Filling stops automatically after about 11 minutes.
<b>IGNITION</b>	The burner is on Ignition process, which mean that has fed with ignition dose of pellet, the heating element (igniter) and the air fan are working. The mode would be automatically changed after detecting a flame by the sensor.
<b>CLEANING</b>	The air fan works at full speed for one minute, to remove the rermaining ashed from the burner's fire chamber. This function takes place alsoat the first minute of ignition
<b>WORK</b>	Heating the boiler up to the set temperature. Showing the actual power of the burner.
<b>MAINTAIN</b>	Sustaining the set temperature (if the burner's working mode is in the mode of continuous work)
<b>BURNING OFF</b>	Putting off the burner. Active in the <b>"STOP"</b> mode or in the temporal working mode of the burner.
<b>STANDBY</b>	Standby of the burner for the decline of the temperature of a hysteresis (if the burner's working mode is in the temporal mode).

## 9. Parameter's

To move round the menu and to set particular parameters there are four buttons placed on the driver's panel: "MODE/↻", "MENU/OK", "+", "-". The parameters chosen by the user are divided into four groups: (A) "CH FURNACE SETTINGS", (B) "WUW BUFFER SETTINGS", (C) "BURNER SETTINGS", (D) "DRIVER SETTINGS". The division of particular parameters in groups is shown in the "Settings' table".

### ➤ CH FURNACE SETTINGS (A)

FUNCTION NO.	FUNCTION NAME	SETTING UNIT	SETTING RANGE	MANUFACTURER SETTING
1	HEATING WATER TEMPERATURE	°C	35 - 85	65*
2	CH PUMP ACTIVATION TEMPERATURE	°C	20 - 60	35*
3	CH FURNACE HYSTERESIS	°C	1 - 20	5*
4	FURNACE MODE	---	Winter/Summer	Winter*

### ➤ WUW BUFFER SETTINGS (B)

FUNCTION NO.	FUNCTION NAME	SETTING UNIT	SETTING RANGE	MANUFACTURER SETTING
1	WUW BUFFER TEMPERATUR	°C	20 - 80	40*
2	WUW SURPLUS TEMPERATURE	°C	5 - 20	10*
3	WUW PRIORITY	---	Yes/No	No*

### ➤ BURNER SETTINGS (C)

FUNCTION NO.	FUNCTION NAME	SETTING UNIT	SETTING RANGE	MANUFACTURER SETTING
1	BURNER POWER (WORK)	kW	10 - 35 10 - 50	30*
2	BURNER POWER (MAINTAIN)	kW	2- 9	3*
3	BURNER MODE**	---	Continuous/ Single/Analogue	Continuous*
4	SELF CLEANING FREQUENCY TIME	Min	10-480	240

5	SELF CLEANING TIME	sec	0-60	0
6	BURNER FLAME MEASUREMENT	%	0-100	-----

**\*\* Burner has 3 modes: continuous mode, single mode and analogue mode.**

**Single mode:** The burner reaches the desired "HEATING WATER TEMPERATURE " and burns off. Then, it starts its operation again when the temperature of the boiler goes down to the temperature "HEATING WATER TEMPERATURE - CH FURNACE HYSTERESIS". The CH FURNACE HYSTERESIS must be more than 10 °C

**Continuous mode:** The burner reaches the desired "HEATING WATER TEMPERATURE " and goes down at 3kW (maintain). When the boiler's temperature goes down to the temperature "HEATING WATER TEMPERATURE - CH FURNACE HYSTERESIS", the burner increases its power from 3kW (maintain) to the maximum burner power (i.e30kW). The CH FURNACE HYSTERESIS must be no more than 5 °C

**Analogue mode:** The burner reduces its power 1/3 (for example: from 30kW to 21kW) 10 °C before the furnace reaches the "HEATING WATER TEMPERATURE ". When the temperature of the furnace is 5 °C before "HEATING WATER TEMPERATURE ", the burner reduces its power again 1/3 ((for example: from 21kW to 12kW).

➤ **DEVICE SETTINGS (D)**

FUNCTION NO.	FUNCTION NAME	SETTING UNIT	SETTING RANGE	MANUFACTURER SETTING
1	LANGUAGE SETTINGS	---	Polish/ English/ German/Greek/ Serbian/...	English*
2	FACTORY SETTINGS	---	Yes/No	---
3	ENABLE SERVICE MODE	---	000 - 999	112

➤ **MANUFACTURER SETTINGS (E)**

FUNCTION NO.	FUNCTION NAME	SETTING UNIT	SETTING RANGE	MANUFACTURER SETTING
1	FILLING FEEDER TIME	minutes	5 - 20	11
2	PELLETS IGNITION TIME	minutes	1 - 15	6

3	FAN POWER (IGNITION)	%	5 - 50	15
4	PELLETS DOSE (IGNITION)	g	50 - 500	240
5	FEEDER PERFORMANCE	kg/h	5.0 - 45.0	14.0
6	PELLETS FEEDING PERIOD	seconds	10 - 60	20
7	OVERFLOW AIR (WORK)	multiplier	0.2 - 2	0.4
8	OVERFLOW AIR (MAINTAIN)	multiplier	0.2 - 2	0.4
9	FLAME DETECTOR TRESHOLD	%	5 - 90	10
10	FURNACE PROTECTION (OVERHEAT)	°C	60 - 90	80*
11	STB TEMPERATURE	°C	60 - 110	90**
12	IGNITION STABILIZATION	Seconds	0 - 250	30
13	MAXIMUM BURNER POWER	KW	30 - 250	35/50
14	MINIMUM BURNER POWER	KW	2 - 50	9
15	MINIMUM FURNACE TEMPERATURE	°C	20 - 60	35
16	SENSOR TYPE		KTY / PT**	KTY
17	EXTERNAL CONTROL	-	Yes / No	No
18	TEMPERATURE CALIBRATION	°C	- 10.0 - 10.0	0.0

\*\* If PT (PT 1000) sensor type is chosen then the range of "STB TEMPERATURE" is 90-250 °C

## 10. Manufacturer's menu

### Activation of Manufacturer's menu

In order to activate the manufacturer's settings menu, go to the settings menu of the driver "DRIVER SETTINGS" and sub-menu "ENABLE SERVICE MODE" and with the help of buttons "MENU/OK" and "+" or "-" choose the code 112. Then, press "MODE/ " and leave the sub-menu, go to the menu "MANUFACTURER SETTINGS"

\* CAUTION!!

Manufacturer's settings are exclusively the suggestion. All of the values depend on the kind of solid fuel, the system, the user's requirements, etc.

The producer of the burner reserves the changes of the ranges of settings in next versions of the driver.

### Description of manufacturer's settings



E. MANUFACTURER  
SETTINGS

#### E1. FEEDER FILLING TIME

In this menu the manufacturer sets the time of the feeder's filling. The time is the protection from filling up of the burner. This time depends on the angle of arrival of the large feeder. The parameter is set in the bracket of 5 to 20 minutes.

Manufacturer Advise: **10-12min**

#### E2. PELLETS IGNITION TIME

In this menu the manufacturer sets the time of the pellet's ignition. After the lapse of time, the ignition cycle restarts. The cycle is repeated once again. Unsuccessful trials of ignition are seen on the screen as a message: **no pellets**. The cause of this condition may be also a broken or dirty flame's sensor. The time of ignition is set in the bracket of 1 to 15 minutes.

Manufacturer Advise: **6-7min**

### **E3. FAN POWER (IGNITION)**

In this parameter the producer sets the power of the fan during the pellet's ignition. The fan's power is set in the bracket of 5 to 50%.

If chimney's draught is over -15Pa, then the parameter stays at 10%

If chimney's draught is from 0 to -15Pa, then the parameter must change to 15-20%.

Manufacturer Advise: **10-15%**

### **E4. PELLETS DOSE (IGNITION)**

In this parameter the manufacturer sets the dose of fuel needed to ignite the burner. The parameter is set in the bracket of 50 to 500 grams. Depending the pellet's quality the parameter can change from 150gram to 220grams. The default value is **240grams**

Manufacturer Advise: **180-240gr for Nani 35**

**200-260gr for Nani 50**

### **E.5 FEEDER PERFORMANCE**

In this parameter the manufacturer sets the performance of the feeder. The whole work of the burner is based on this parameter. The parameter is set in the bracket of 5 to 45 kg/h with the step of 500grams.

Manufacturer Advise: **Can not be given any advise since it is depended on the feeder's angle and pellet quality. Please follow the procedure on paragraph 11 "First use**

### **E6. PELLETS FEEDING PERIOD**

In this parameter the manufacturer sets the period of feeding the pellet. After the lapse of time, the driver releases the next dose of fuel. In the cycle of maintain, the parameter is ten times multiplied. The feeding period of the pellet is set in the bracket of 10 to 60 seconds.

Manufacturer Advise: **10-20s**

### **E7. OVERFLOW PELLETS AIR (WORK)**

In this parameter the manufacturer sets the overflow of the air needed to burn the specified amount of the pellet when the burner works at full power.. This parameter should be increased if during the working cycle too low capacity of the fan would be noticed. The overflow of the air is set in the bracket from 0.2 to 4.

**Depending on the burner's maximum power ,pellet's quality, boiler's construction and chimney's draught, the paramater will be set between 0.20-0.6**

**E8. OVERFLOW PELLETS AIR (MAINTAIN)**

In this parameter the manufacturer sets the overflow of the air needed to burn the specified amount of the pellet during "Maintain" mode. This parameter should be increased if during the working cycle too low capacity of the fan would be noticed. The overflow of the air is set in the bracket from 0.2 to 4.

**Depending pellet's quality, boiler's construction and chimney's draught, the "parameter will be set between 0.20-2.0**

**E9. FLAME DETECTION TRESHOLD**

In this parameter the manufacturer sets the flame's detection threshold. Beneath the pre-set threshold's value, the burner detects the vanishing of the flame. The parameter is set in the bracket of 5 to 90%.

Manufacturer Advise: **10%**

**E10. FURNACE PROTECTION (OVERHEAT)**

In this parameter, the user sets the furnace's temperature which protects from the overheating. The protection is activated when a higher temperature than the one that was previously set is reached and when the CH pump is turned off. The driver starts the CH pump automatically and switches off the burner. The protection of the furnace from the overheating is set in the bracket of 60 to 90 °C. The furnace's protection can be activated when:

- working of room thermostat and simultaneously surpassing the protection temperature of the furnace,
- setting "**Summer**" function and simultaneously surpassing the protection temperature of the furnace,
- setting the "**STOP**" mode and simultaneously surpassing the protection temperature of the furnace,
- surpassing the temperature of the heating water over 90 °C.

Manufacturer Advise: **80-90 °C**

**E11. STB TEMPERATURE**

It is the temperature where the Overheating Alarm is activated. At the same time the controller activates the CH pump and the WUW pump. For water boiler the default value is 90 °C.

If sensor type PT is chosen then, the value of this parameter can change depending the



application.

### **E12. IGNITION STABILIZATION**

When ignition has occurred, the air-fan works for the time, which has been set by this parameter. This operation drives the ignition gases out of the boiler faster.

Manufacturer Advise: **30-60sec**

### **E13. MAXIMUM BURNER POWER**

In this parameter the installer can set the maximum burner power, where the user can set by visiting the burner's menu. This prevents the user to set the burner at a maximum power, than the one it is required by the system.

Manufacturer Advise: **35kW for Nani 35 / 50kW for Nani 50**

### **E14. MINIMUM BURNER POWER**

In this parameter the installer can set the minimum burner power, where the user can set by visiting the burner's menu. This prevents the user to set the burner at a maximum power, than the one it is required by the system.

Manufacturer Advise: **9kW**

### **E.15 MINIMUM FURNACE TEMPERATURE**

In this parameter the manufacturer sets the minimal temperature of the furnace which can be set by the user. The activity of the room thermostat causes the setting of the boiler into this parameter. The minimal temperature of the boiler is set in the bracket of 20 to 60 °C.

Manufacturer Advise: **35 °C**

### **E16. SENSOR TYPE**

In this parameter the installer can choose between KTY ant PT 1000 temperature sensors.

KTY is the default sensor which is used for measuring temperatures up to 100 °C.

The PT 1000 sensor is given by the manufacturer under request and it is used to measure temperature higher than 100 °C (industrial applications).

Notice: Nani 35 is not suggested to be installed in industrial applications.

### **E.17 EXTERNAL CONTROL (room thermostat)**

This parameter, it is activated only if room thermostat it is connected on the controller

**If external control No**(Manufacturer's settings):

1. When thermostat is ON, the burner works at the maximum power it is set.
2. When thermostat is OFF, the burner burns off

This is mostly suggested for low consumption houses (less than 3.000kg/year) or for connecting with timer.

**If external control Yes**(Manufacturer's settings):

1. When thermostat is ON, the burner works at the maximum power it is set.
2. When thermostat is OFF, the burner goes at maintain mode and keeps a small fire.

In both cases, when the thermostat is OFF, the CH pump stops.

## E.18 TEMPERATURE CALIBRATION

In this menu the manufacturer calibrates the temperature sensors. It is possible to add a regular offset for the temperature of the furnace and the warm useful water. The parameter is set in the bracket of -10 to +10°C.

## 11. Room thermostat

The room thermostat (or any external command) can be connected on the **PINs 1&2**, which are located on the PCB board inside the burner's controller (black casing)



**It is forbidden to give voltage to room thermostat's connection (pin 1&2). The connection with the room thermostat must be only a "Cold junction"**

When a room thermostat is connected in the controller, we have the two following options:

**If external control No**(Manufacturer's settings):

1. When thermostat is ON, the burner works at the maximum power it is set.
2. When thermostat is OFF, the burner burns off

This is mostly suggested for low consumption houses (less than 3.000kg/year) or for connecting with timer.

**If external control Yes**(Manufacturer's settings):

1. When thermostat is ON, the burner works at the maximum power it is set.
2. When thermostat is OFF, the burner goes at maintain mode and keeps a small fire.

**In both cases, when the thermostat is OFF, the CH pump stops.**

## 12. First use – adjusting the burner's fire

1. Ensure that the installation has been done according to this manual
2. Ensure that the plastic pipe **is not** connected to burner's feeding pipe
3. Fill the feeder up with wood-pellet, by following the direction of paragraph 16 (**Feeder's Filling Procedure**). The filling of the feeder lasts 8-15min depended on feeders incline.
4. Ensure that the feeder is full of pellet. Let the feeder working after the first pellets come out of the feeder for 10-15 minutes (locate a plastic bag at the exit of the feeder)
5. Empty the plastic bag and place it back at the exit of the feeder.
6. Make the feeder work again for 2 minutes, by pressing the button 
7. Weight the wood pellet which is in the bag (for example 0.4kg)
8. Multiply it by 30 minutes ( $0.4 \times 30 = 12\text{kg/hr}$ ). This is the **feeder's performance**
9. **Repeat the steps 4-8**, 2-3 times until you make sure that you weight the right quantity.
10. **Place this value (i.e 12kg/hr) on manufacturer's settings menu, in the parameter "5. Feeder Performance"**
11. **"CHOICE FUNCTION-/+ " is written on the screen.**
12. By pressing the button "MODE/↻" once, starts the automatic operation of the burner
13. When the maximum power of the burner is reached (from 10 to 35kW), then adjust the burners flame by calibrating the air.

**The burning air is calibrated just by changing the value of "Overflow pellet's air" at Manufacturer's menu. The value must be between 0.20-0.7, depending on the maximum burner's power, pellet quality, boilers construction and chimney's draught.**

## 13. Start of the burner

1. Activate the burner by connecting it with a power supply (230Volt, 50Hz)
2. It is written on the LCD screen the following

CH:---- °C WUW:---- °C  
STOP

3. By pressing the button "MODE/↻" once changes the operation from "Stop" to



"ignition". By pressing the button "**MODE/**" changes the operation from "**Ignition**" to "**Automatic**".

- In "Automatic mode", starts the operation of the burner.

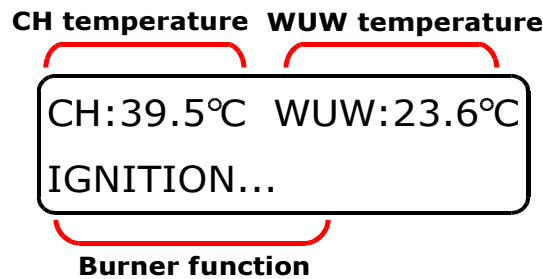

- When the photo sensors detects fire, then the burner starts its "Work" by increasing its power gradually to the power it has been set (i.e 30kW)
- When the boiler's water temperature reaches the desired temperature "HEATING WATER TEMPERATURE ", the the power of the burner goes down ta 3kW (**Maintain mode**)
- The burner works at "Maintain mode" till the boiler's water temperature goes down to the temperature:



"HEATING WATER TEMPERATURE - CH FURNACE HYSTERESIS"

## 14. Stop of the burner

- The burner can be either at "**Work**" or "**Maintain**" or "**standby**"
- Press the button "**MODE/↻**" continuously till "**STOP MODE**" appears on the screen.
- It is written "*Burning off*" till the photo sensor stops to detect fire (3-5 min)
- When he photo sensor stops to detect fire, "cleaning procedure takes place for few seconds.



## 15. Cleaning burner's chamber

- The burner can be either at "**Work**" or "**Maintain**" or "**standby**"
- Press the button "**MODE/↻**" continuously till "**STOP MODE**" appears on the screen.
- It is written "**Burning off**" till the photo sensor stops to detect fire (3-5 min)
- When he photo sensor stops to detect fire, "cleaning procedure takes place for few seconds.
- When "**Stop**" appears on the LCD screen, waiting few minutes till the burner cools down.
- Open the boilers door, clean the burners tube and close back the door.

7. By pressing the button "MODE/  " once changes the operation from "Stop" to "ignition". By pressing the button "MODE/  " changes the operation from "Ignition" to "Automatic".





**\*\* The frequency of cleaning burner's chamber is depended on wood pellet's quality. If premium pellet is used, It is suggested the burner's chamber to be cleace a week.**

## 16. Restart the burner after an error

1. Turn off the burner by using the electric switch the burner is connected
2. Open the boiler's door and check the burners tube.
3. Remove any ashes and impurities from burners fire chamber.
4. Close the door and switch on the controller by using the electric switch the burner is connected
5. By pressing the button "MODE/  " once changes the operation from "Stop" to "ignition". By pressing the button "MODE/  " changes the operation from "Ignition" to "Automatic"



## 17. Feeder's filling procedure

1. Remove the plastic tube connection the burner with the feeder
2. Burner must be at stop mode. So, "Stop" appears on the LCD scree
3. By pressing the button "MODE/  " once changes the operation from "Stop" to "ignition".
4. "CHOICE FUNCTION-/+ " appears on the LCD screen
5. Press the button  to start the feeder
6. Feeders operation lasts 11min (Manufacturer's setting / Feeder's filling time"
7. When the wood-pellet starts to come out of the feeder, press  to stop the feeder
8. Connect the feeder with the burner, by using the plastic pipe.
9. If the "Feeder's filling time" is not enough, press  to start the feeder again

## 18. Self cleaning system

**Self cleaning can be activated only when the burner is equipped with an electro-valve and it is connected with an air-compressor.**

**Minimum requirements for air-compressor:** 10Lt at 7bar, or 6Lt at 8 bar

**The installation of self cleaning is very easy.**

1. Connect the solenoid valve which is located on the burner with the air-compressor by using the plastic pipe is provided with the burner.
  2. Set the **"SELF CLEANING FREQUENCY TIME" on parameter C4.** : It is the maximum time the burner can work without interrupted by Self Cleaning procedure.
  3. Set the **"SELF CLEANING TIME" on parameter C5** : It is the time the electro-valve is activated to remove the ashes form the burner. It is suggested to be set 3-5sec.
- **Activation of self cleaning:** It is activated by changing the parameter "SELF CLEANING TIME" from "Off" to "xsec" (for example 3sec)
  - **Deactivation of self cleaning :** It is deactivated when the parameter C5. Is set at "Off"

## 19. Burners safety systems

**For total, fail-safe security, the burner is equipped with four safety systems:**

1. The plastic pipe connecting the feeder with the burner. This tube will melt away from the burner in event of a too high temperature, thereby breaking contact between pellets fuel replenishment and the burner.
2. The burner's fall-tube is equipped with a back-burn protection system which is triggered at 65 °C. The back-fire protection system is placed on the fall-tube. In the event of the alarm being triggered always investigate the cause and rectify.
3. The Overheating Boiler sensor (STB sensor), which is activated when the boiler's temperature is higher than 95 °C. When this protection is activated, the light next to the STB sensor is ON and the the feeder is turned off. The, you must reset the STB sensor, the feeder to work again.
4. The photo sensor senses that ignition has taken place and is running normally.

## 20. Errors

Indication	Description	Solution /
<div style="border: 1px solid black; padding: 5px;">           CH: !!!!!      WUW: !!!!!            STOP         </div>	Malfunction of the water temperature sensors	<ol style="list-style-type: none"> <li>The driver starts up relevant emergency procedures for every sensor in order to prevent the boiler from working beyond the safe range for the installation of the central heating</li> <li>When the boiler cools down, then restart the controller and set the burner on automatic mode.</li> </ol>
<b>"Furnace protect"</b>	<p>The temperature in the boiler is higher than 92 °C. If the temperature is above 95 °C, the STB sensor is activated and the feeder is turned off automatically (the light next to the STB sensor is ON).</p> <p>At any case the pumps are activated to avoid higher temperatures</p>	<ol style="list-style-type: none"> <li>Wait till the boilers water temperature goes down to 60 °C</li> <li>Reset the STB sensor, so the light next to it to be OFF.</li> <li>Restart the controller and set the burner at automatic mode.</li> </ol>
<b>"Burner alarm"</b>	<p>The temperatures on burner's feeder pipe is higher than 70 °C. (Back fire protection)</p> <p>This is happened either the chimney's draught is no the appropriate or the burner hasn't been cleaned.</p>	<ol style="list-style-type: none"> <li>If the temperature goes down to 60 °C and the photo sensor scans light, then the burner's operation continuous normally.</li> <li>If the temperature goes down to 60 °C and the photo sensor doesn't scan any light, then the signal "Burner alarm" is still on the LCD and you must restart the controller.</li> </ol>
<b>"NO pellet"</b>	1. No pellet on the silo	<ol style="list-style-type: none"> <li>Fill up the silo with pellet</li> <li>Fill the feeder with pellet (Filling feeder procedure)</li> <li>Set the burner at automatic mode</li> </ol>
	2. The feeder doesn't work	<p>If the light next to STB sensor is ON, it means that overheat of the boiler has occurred and STB has turned the feeder OFF.</p> <ol style="list-style-type: none"> <li>Reset the STB sensor, so the light next to it to be OFF.</li> <li>Restart the controller and set the burner at automatic mode.</li> </ol> <p>Check the cable from feeder to the controller</p>
	3. Problem during ignition procedure	<p>Burner's tube hasn't been cleaned properly</p> <ol style="list-style-type: none"> <li>Clean the burner</li> <li>Restart the controller and set the burner at automatic mode.</li> </ol> <p>Igniter doesn't work</p> <ol style="list-style-type: none"> <li>Change the igniter inside the burner.</li> </ol>

## 21. Electrical diagram

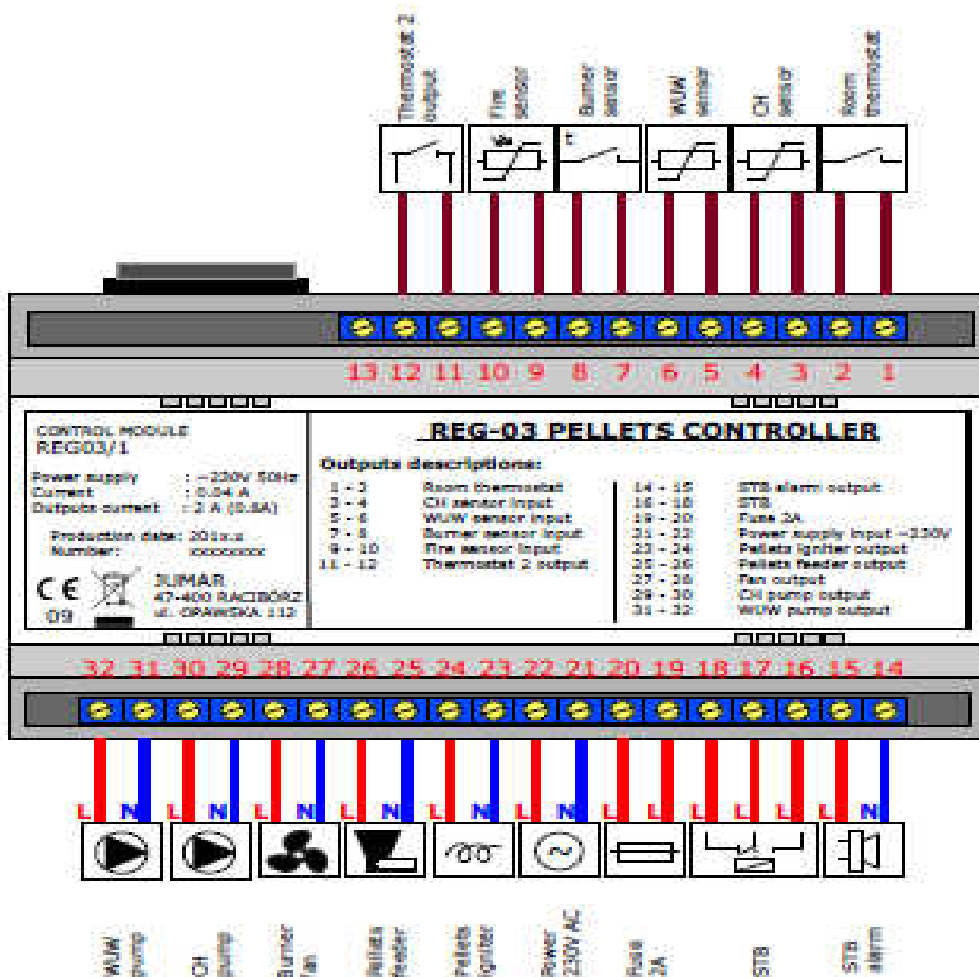



## **22. Warranty**

2-years in metal parts

2-years in electric parts (feeder's motor & air-fan)

2-year in electronic controller

No warranty is given for the heating element (igniter)



Vasilika, Thessaloniki 57006, Greece

+30 2396 023437

[www.megatherm.gr](http://www.megatherm.gr)

[info@megatherm.gr](mailto:info@megatherm.gr)